

Compression Load Cell

FEATURES

- Capacities: 10–100 t
- Low profile, multi-column stainless steel construction
- Hermetically sealed, IP66, IP68, and IP69K
- Certified to OIML R-60, 4000d and NTEP class III L 10000 divisions
 - Model CSP offers klb capacity, imperial thread and NTEP approval
 - Model CSP-M offers metric capacity, thread and OIML approval
- Built-in surge protection tubes (GDTs)
- Current calibration output (SC version) ensures easy and accurate parallel connection of multiple load cells
- **Optional**
 - ATEX and FM certified versions are available for use in potentially explosive atmospheres
 - Multi-interval and multiple range versions available
 - Imperial capacities (25k, 50k, 100k, 200k lbs) not OIML approved



DESCRIPTION

The CSP is a multi-column, low profile, stainless steel compression load cell. The unique four column design offers excellent insensitivity to eccentric loads while maintaining accuracy.

This product is suitable for use in road and rail weighbridges and process weighing applications.

The fully leak-tested welded construction, advanced cable entry, and built-in surge protection tubes ensure that this product can be used successfully in harsh environments.

This product meets the stringent Weights and Measures requirements throughout Europe.

APPLICATIONS

- Truck and rail weighbridges
- Silo and hopper weighing
- Process weighing

OUTLINE DIMENSIONS in millimeters

Cable specifications

- Standard Cable length 20 m
- Excitation + Green
- Excitation - Black
- Output + White
- Output - Red
- Shield Transparent

Cable screen is not connected to load cell body. Performance may be affected if load cell cables are shortened.

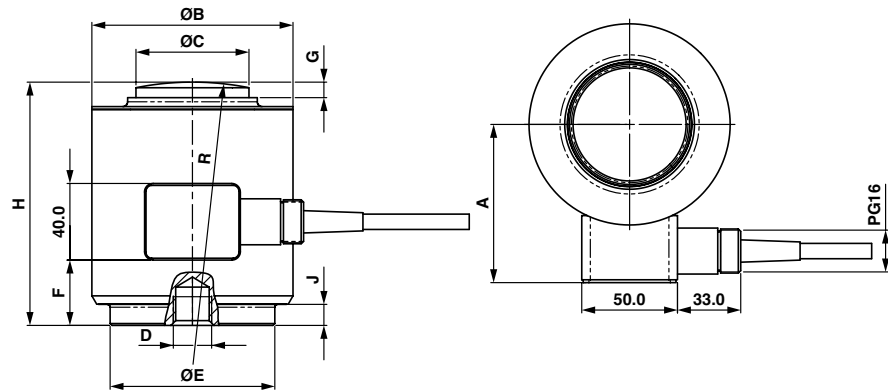

Optional mounting kit—consult Sales Office

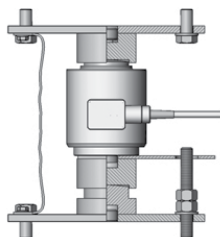

Capacity	A	B	C	D	E	F	G	H	I	J
CSP-M										
10–25 t	63	72	32	M12 x 8 Deep	57	13	7	83	2	150
40–60 t	83	105	59	M20 x 20 Deep	86	35	8	127	11	150
100 t	107	150	80	M20 x 20 Deep	124	70	22	185	20	430
CSP										
10–50 klb	63	72	32	1/2" x 11 Deep	57	13	7	83	2	150
100 klb	83	105	59	3/4" x 20 Deep	86	35	8	127	11	150
200–300 klb	107	150	80	3/4" x 20 Deep	124	70	22	185	20	430
500 klb	122	167	94	3/4" x 20 Deep	136	91	15	228	25	432

Compression Load Cell

SPECIFICATIONS					
PARAMETER	VALUE				UNIT
Standard capacities (E _{max})	10, 25, 40, 60, 100 ⁽¹⁾ 10 ⁽²⁾ , 25, 40, 50, 60, 75, 100, 150, 200, 300 ⁽²⁾ , 500 ⁽²⁾				t klb
Accuracy class according to OIML R-60/NTEP	NTEP IIIIL	NTEP IIIIL	C3	C4	
Maximum no. of verification intervals	10000	3000	3000	4000	
Minimum verification interval (V _{min} =E _{max} /Y) ⁽³⁾	E _{max} /5200	E _{max} /29000	E _{max} /12,500	E _{max} /12,500	
Minimum verification interval, type MR			E _{max} /17,500	E _{max} /17,500	
Rated output (=S)	2				±mV/V
Rated output tolerance	0.02				±mV/V
Zero balance	1.0				mV/V
Total error	0.02	0.05	0.023	0.017	±% FSO
Nonrepeatability	0.01	0.01	0.01	0.009	±% FSO
Zero return	0.015	0.0167	0.0167	0.0125	±% applied load
Creep error (30 minutes)	0.05	0.035	0.0245	0.0184	±% applied load
Temp. effect on min. dead load output	0.00144	0.0027	0.0011	0.0011	±% FSO/°C
Temp. effect on min. dead load output, type MR			0.0008	0.008	±% FSO/°C
Temperature effect on sensitivity	0.00144	0.00144	0.001	0.0007	±% applied load/5
Maximum safe static overload	150				% E _{max}
Ultimate static overload	400				% E _{max}
Maximum safe side load	10				% E _{max}
Excitation voltage	5 to 20				V
Excitation recommended	10				V
Input resistance	450 ±4.5				Ω
Output resistance	480 ±4.8				Ω
Insulation resistance	>5000				MΩ
Compensated temperature range	-10 to +40				°C
Operating temperature range	-40 to +80				°C
Storage temperature range	-50 to +90				°C
Element material	Stainless steel 1.4542				
Sealing (DIN 40.050 / EN60.529)	IP66 and IP68				

⁽¹⁾ 100 t only has C1 grade of OIML

⁽²⁾ 10, 300, 500 klb are not NTEP approved

⁽³⁾ Approval limit: Class III V_{min}=E_{max}/10000 (0.0014% Of FSO/°C); Class IIIIL V_{min}=E_{max}/30000 (0.0014% Of FSO/°C)

FSO— Full Scale Output

SC-version: The rated output and the output resistance are balanced in such a way, that the output current is calibrated to within 0.05% of a reference value. This allows easy parallel connection of the load cells.

All specifications subject to change without notice.

Disclaimer

ALL PRODUCTS, PRODUCT SPECIFICATIONS AND DATA ARE SUBJECT TO CHANGE WITHOUT NOTICE.

Vishay Precision Group, Inc., its affiliates, agents, and employees, and all persons acting on its or their behalf (collectively, "VPG"), disclaim any and all liability for any errors, inaccuracies or incompleteness contained herein or in any other disclosure relating to any product.

The product specifications do not expand or otherwise modify VPG's terms and conditions of purchase, including but not limited to, the warranty expressed therein.

VPG makes no warranty, representation or guarantee other than as set forth in the terms and conditions of purchase. **To the maximum extent permitted by applicable law, VPG disclaims (i) any and all liability arising out of the application or use of any product, (ii) any and all liability, including without limitation special, consequential or incidental damages, and (iii) any and all implied warranties, including warranties of fitness for particular purpose, non-infringement and merchantability.**

Information provided in datasheets and/or specifications may vary from actual results in different applications and performance may vary over time. Statements regarding the suitability of products for certain types of applications are based on VPG's knowledge of typical requirements that are often placed on VPG products. It is the customer's responsibility to validate that a particular product with the properties described in the product specification is suitable for use in a particular application. You should ensure you have the current version of the relevant information by contacting VPG prior to performing installation or use of the product, such as on our website at vpgsensors.com.

No license, express, implied, or otherwise, to any intellectual property rights is granted by this document, or by any conduct of VPG.

The products shown herein are not designed for use in life-saving or life-sustaining applications unless otherwise expressly indicated. Customers using or selling VPG products not expressly indicated for use in such applications do so entirely at their own risk and agree to fully indemnify VPG for any damages arising or resulting from such use or sale. Please contact authorized VPG personnel to obtain written terms and conditions regarding products designed for such applications.

Product names and markings noted herein may be trademarks of their respective owners.

Copyright Vishay Precision Group, Inc., 2014. All rights reserved.